

PAQTEQ C-250

Simply save on packaging

Customized packaging – environmentally friendly and sustainable.







Pack everything simply – not just furniture parts – and save big in the process

Our PAQTEQ C-250 cardboard cutting machine produces precise, individual and resource-saving packaging solutions – fully automatic, just-in-time and made-to-measure. You save storage space for many packaging sizes. This allows you to react individually and, above all, quickly to new requirements, and to invest the resources saved for your next steps. At the same time, by using the PAQTEQ C-250, you help to reduce transport volumes and thus cut CO² emissions. One solution – many advantages.

YOUR SOLUTION

MORE: [HOMAG.COM](https://www.homag.com)



PAQTEQ C-250

CONTENTS

- 04 Customized packaging
- 06 Why the PAQTEQ?
- 12 Layout + function
- 13 Creasing, cutting and perforating
- 14 PAQTEQ-Basic machines
- 16 Feeding systems
- 18 powerTouch and intelliCut
- 20 PAQTEQ Shop
- 22 Packaging systems
- 24 Life Cycle Services
- 26 Technical data
- 27 Checklist



A variety of product designs, increasing cost pressure for manufacturers and logistics businesses, as well as tighter statutory requirements.

Product-specific packaging made from ecologically harmless material with a high volume-utilization factor is a viable solution.

Customized packaging – environmentally friendly and sustainable.

Sensitive products and high-quality goods need special protection and stability. Packaging is designed specially to offer optimum properties for transport, storage and sales. For the PAQTEQ C-250, designers and craftsmen around the world are developing cuts that can be called up directly from the machine via the Internet and, with just a few entries, adapted to the specific needs of the goods being packaged.

With the models of our cardboard box cutting machines, we have the right solution for every customer. From entry-level models up to high-performance machines, from standard use to complex packaging cutting. With the PAQTEQ C-250, produce exactly the packaging that you need – in optimal form, with a high volume-utilization factor and the lowest possible unit costs.

"With the PAQTEQ cardboard box cutting machine, you expand your horizons for using the packaging all-rounder that is corrugated cardboard. Increase efficiency in your logistics chain by using customized, environmentally friendly cardboard boxes — made on the PAQTEQ."

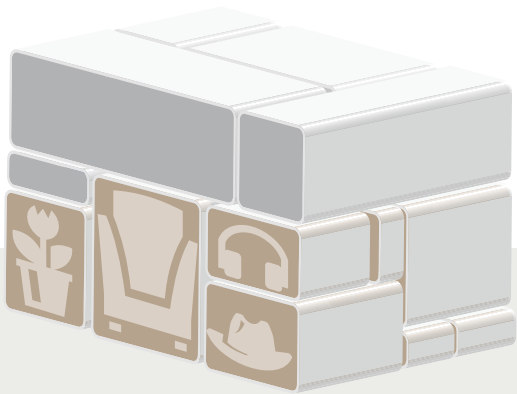

Optimization of the dimensions and arrangement as well as packaging and palleting instructions.



Adaptation of the entire packaging system leads to an economical, damage-free transport system.



Why the

PAQTEQ ?

1. Efficient product protection

Package your "star" appropriately so that the first impression on your customer is right.

2. Save money

More efficient purchasing and simpler logistics as only a few basic cardboard boxes are usually required.

3. Save a lot of space

Saved storage space can be used for other things that make you better.

4. Individuality of the cardboard boxes

Established technology and access to 100s of patterns in seconds make it possible to react to new measurements.

5. Sustainability

Thanks to our clever cutting of corrugated cardboard (made from renewable raw material and therefore also easily recyclable), you need fewer alternative fillers.



1. Product protection

Professionally and securely packaged

- Specific packaging designs ensure the protection and secure hold of the product during transport and storage, as the size of the packaging has been individually adapted to the contents.
- There is no need to use filling material made of PVC, polystyrene, etc → Single-material packaging.
- The protective function of the packaging is performed entirely by the corrugated board.



100%
Improvement in
product protection

"Today, we package 98% of all carcass types according to the PAQTEQ concept, despite batch size 1 production. The surfaces and edges of these carcasses are now better protected against impacts."

Heinz-Peter Tillmann – SieMatic

2. Cost saving

Precisely packaged, crisply calculated

- Reduction of warehousing costs (buildings, personnel, stock, fire protection, etc.).
- Reduction of logistics costs (personnel, conveyor equipment, etc.).
- Reduction of purchasing costs (number of suppliers, reduction of carton assortment, reduction of fillers, etc.).



85%
Total cost saving

"Before we had the machine, we kept about 70 different carton sizes in our warehouse, and of the 70 sizes, 60 mostly didn't fit and were difficult to manage. Now we use corrugated board to produce exactly the carton we need."

Thomas Sparrer – Conzella

3. Space saving

Produce cheaply instead of storing expensively

- Minimum purchase quantities of standard cartons and filling material are eliminated.
- The use of continuous cartons reduces storage and procurement costs.
- The PAQTEQ C-250 enables just-in-time production, i.e. the right carton is produced at the touch of a button – without large-scale warehousing.



Up to 50%
space saving!

"We chose a PAQTEQ C-250 because we needed half a floor up front to stock the amount of different packages to store them so they could be brought to the cabinets during the production process."

Heinz-Peter Tillmann – SieMatic

4. Individuality

Conveys the own claim to the customer

- The packaging has a high-quality look.
- Conscious control of the customer's brand experience.
- You can increase customer satisfaction with the packaging.



50%
Cost reduction

"The carton cutting machine has the advantage for us that we can produce small quantities particularly inexpensively. Compared to the previous purchase costs, we save up to 50%."

Thomas Sparrer – Conzella

5. Sustainability

Cost-effective, customised cardboard

- Corrugated board consists entirely of renewable raw materials (mainly recycled paper, broken and thinned wood).
- Corrugated board combines low material input, low weight, good machinability, high stability and effective product protection.
- Corrugated board is single-material and therefore easy to recycle.
- Elimination of plastics in packaging.



12–15%
less waste



"The result of the collaboration with HOMAG was the side-by-side solution, which allows us to use not just 6 different cardboard boxes as the base material for our packaging, but 12.

This therefore results in a significantly lower offcut quantity. The savings are in the range of 12 – 15 %."

Heinz-Peter Tillmann – SieMatic



35% less volume

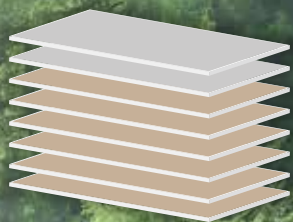

25% less cardboard



9,900,000
fewer trees per year have to be felled

Customized, environmentally friendly packaging – manufactured on the **PAQTEQ cardboard box cutting machine**

Carton cutting machines process corrugated board into individual cartons. The cardboard is cut in a continuous process, i.e. the feed system automatically transports the corrugated cardboard into the automatic cutting machine. From single sheets to endless cardboard boxes with 12 different web widths – the PAQTEQ cardboard cutting machine offers the right cardboard feeding system for almost every requirement.



The **directly accessible and illuminated cutting chamber** facilitates process control and maintenance work.



Tools

Outstanding quality for pinpoint machining

With the cutting tools of the PAQTEQ C-250, which can be moved fully automatically and set up quickly, almost any blank can be produced. The tools running on rubber rollers ensure lower cutting forces and less wear, with the best cutting quality and long tool life. The cross tool cuts in a groove. The tool can be moved individually according to requirements and carton design. The cardboard can be completely cut or only perforated.

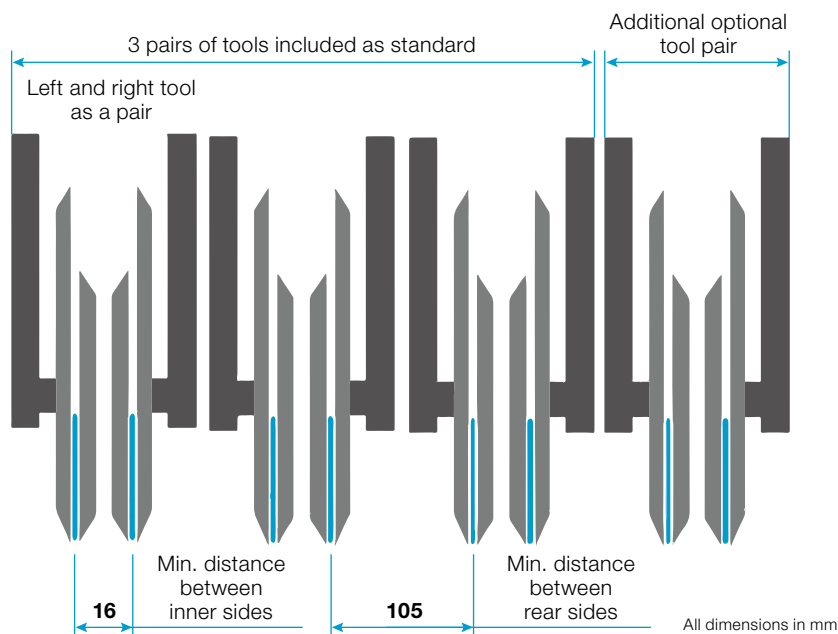

- The machine works according to the "single point" principle. A circular blade runs between 2 creasing rings. This means that 3 work steps can be completed in one pass.
- 3 longitudinal tool pairs as standard.
- Pneumatic feed of the complete tool and the circular blade.



Lots of protection, hardly any space required 1,500 or 2,500 mm basic machine width

Space is limited, but the technical solution is not. For customers with limited space, we also have a narrow version of the PAQTEQ C-250, which does not lose anything in terms of features and application possibilities compared to the footprint.



Width 1,500 mm | VKS 1500

- Basic machine with 3 rubberised rollers (feed of the cardboard and cutting roller)
- Working area with one transverse tool and 6 or 8 longitudinal tools
- Cross tool driven via axis
- Longitudinal tool positioning via axis of the cross tool
- **Working width: 1,500 mm**
- **Machine width: 2,395 mm**



Width 2,500 mm | VKS 2500

- Basic machine with 3 rubberised rollers (feed of the cardboard and cutting roller)
- Working area with one transverse tool and 6 or 8 longitudinal tools
- Cross tool driven via axis
- Longitudinal tool positioning via axis of the cross tool
- **Working width: 2,500 mm**
- **Machine width: 3,390 mm**

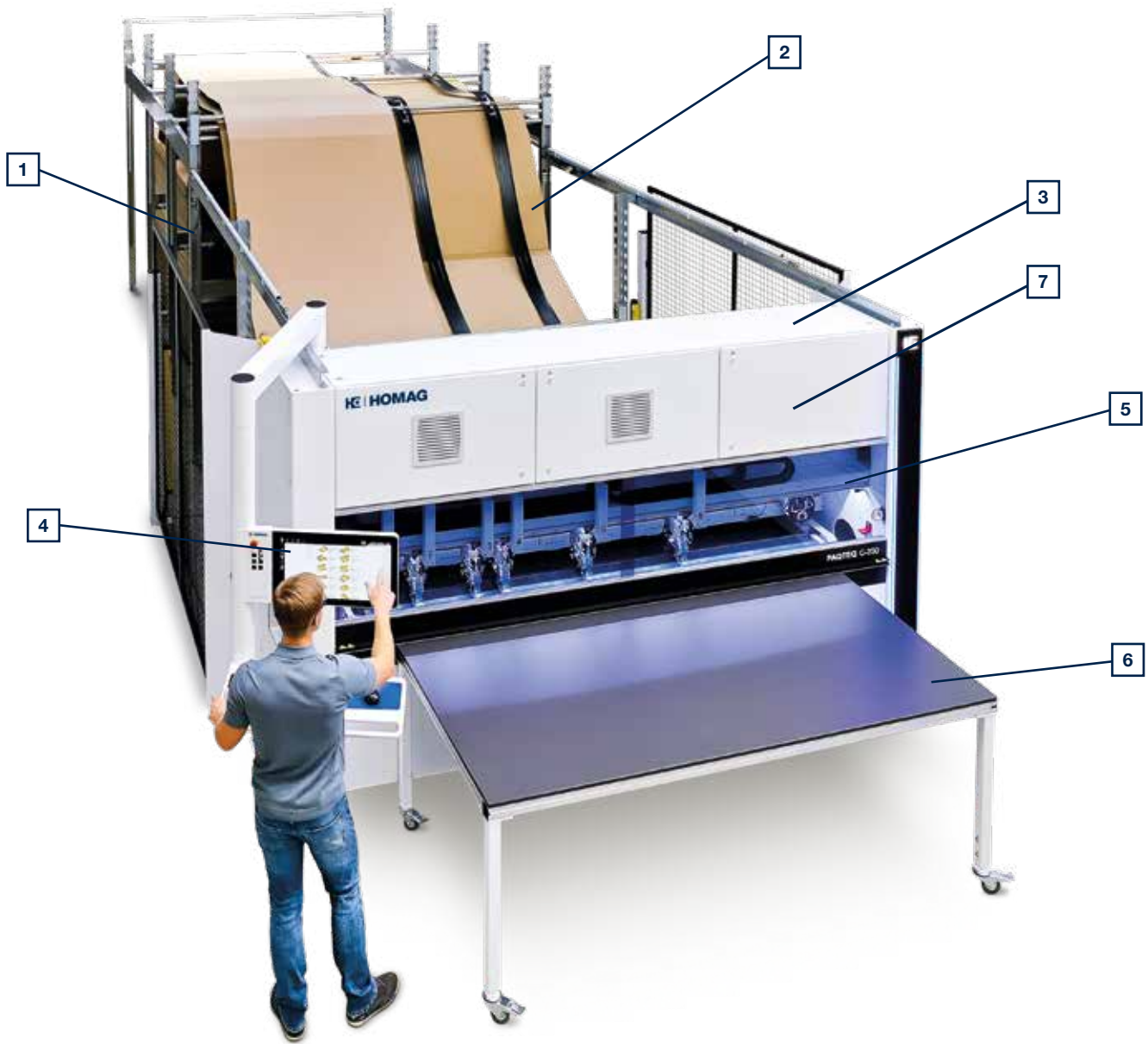

1 Feed system transports corrugated cardboard into the cutting machine, from single-sheet feed to a continuous magazine with a change function.

2 Continuous cardboard as corrugated cardboard without being tied to a supplier, reduces storage costs and can be printed on an individual basis.

3 Cutting machine with a maximum of nine multifunctional cutting tools for almost any cardboard box design.

4 Operating terminal mounted directly on the machine via swivel arm – optionally on the left or right. Intuitive control of the machine via **intelliCut** software.

5 Illuminated cutting area, particularly easily accessible for maintenance and for maintaining tools.

6 Deposit table supports the operator during outfeed of the finished cuts and improves the ergonomics at the workstation.

7 Control cabinet with computer and pneumatic connection integrated into the machine above the working area.

A wide range of possibilities: Our cardboard box feeding systems

1.

Combination carton feeder

- 1 carton width up to 2500 mm wide
- 2 carton widths up to 2350 mm total width simultaneously accessible
- Control decides which one is used (waste-optimised)

Manual single-sheet infeed

- Sheet material up to max. 2500 mm wide
- Endless cartons also possible under certain conditions

2.

Cardboard box changing system

- 2 – 6 carton feeders in a row
- Optionally for 1300 mm or 2200 mm stacking height
- higher flexibility and due to the then given use of different carton widths to reduce waste.
- From each position, two stacks can be fed side by side into a compartment of the automatic changer with the "side by side" option.

Manual single-sheet infeed from the front

- Sheetfed products up to max. 2500 mm length and 2400 mm width
- In conjunction with carton changer system (however, max. 5-fold changer possible, one tray is required for this function)
- Incl. table in front of the delivery
- With side ruler to position the single sheets
- With foot stops to lock the position on the basic machine

3.

Automatic cut-sheet infeed

- Sheets up to max. 2500 mm length and width
- Pile height incl. support max. 800 mm
- Separation of single sheets by vacuum separating device
- Re-clocking lifting table

Carton cutting machines process corrugated board into individual cartons. The cardboard is cut in a continuous process. The feed system automatically transports the corrugated board into the automatic cutting machine. From single sheets to endless cardboard boxes, with 12 different web widths at the same time. The PAQTEQ carton cutting machine offers the right carton feed system for almost every requirement.



The **combi-carton feeder** enables the feeding of single sheets as well as the use of continuous cartons.



When using **production lists**, carton production is automated. Interruptions with individual cuts are possible without the last settings being "forgotten".



In the **side-by-side** operating mode, the carton feed compartment is extended by another web width, so that up to 12 web widths are possible in single access with a 6-compartment changeover system.



The **endless carton changer** is an automatic changing system for endless web widths with up to six compartments.



The **single-sheet feeder** enables the feeding of individual packaging sheets as well as the use of continuous cardboard without a reel.



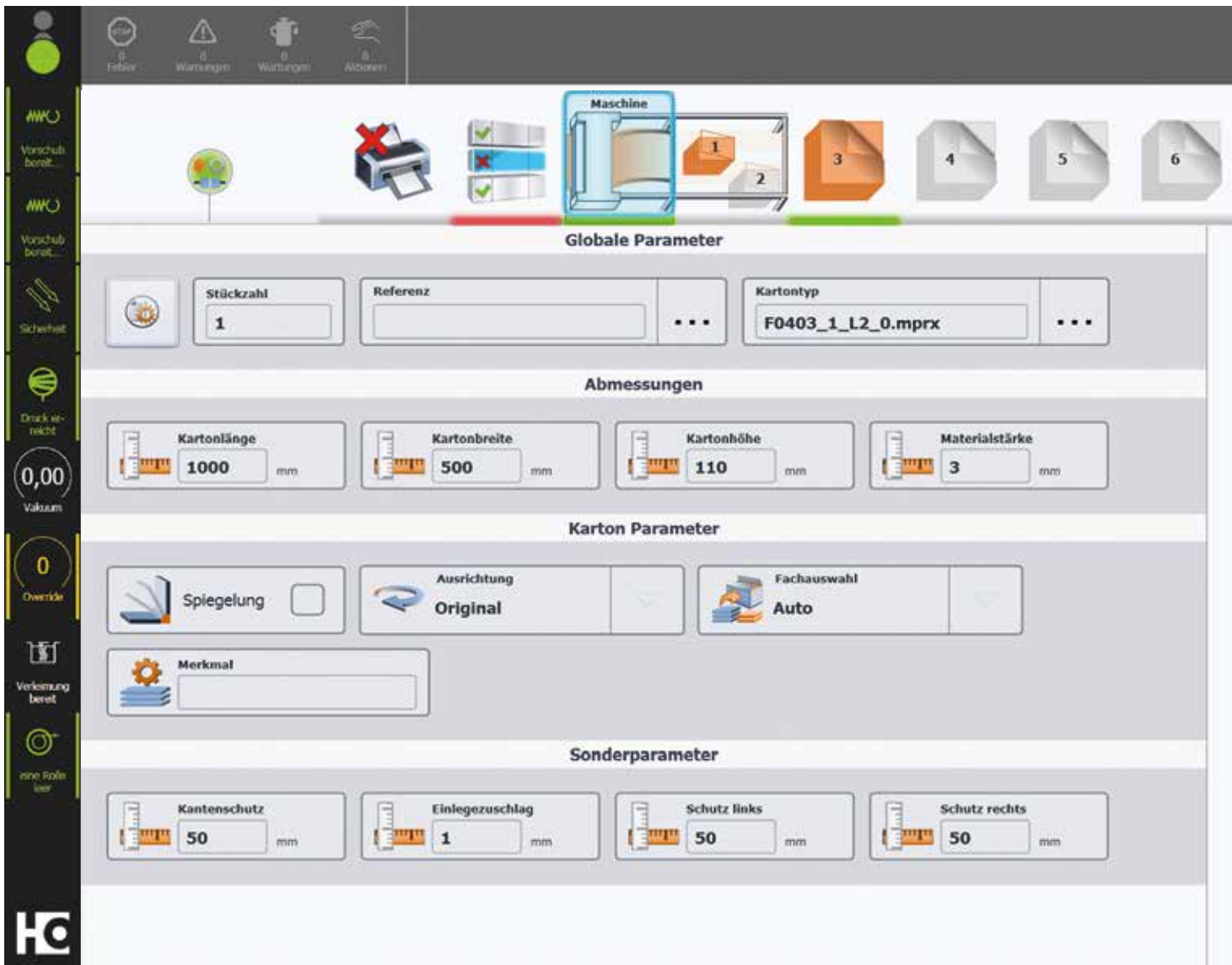

intelli**Cut** –
a machine operation
that's as intuitive as a
smartphone!

The PAQTEQ intelligent machine control unit monitors itself and, if necessary, performs an automatic recalibration to ensure highly accurate cutting precision can be sustained. To optimize the ordering of materials, all cardboard box cuts are recorded automatically and evaluated statistically over a period of three months. The display includes the track widths and the 10 cuts with the most waste.



The **waste optimization** calculates the ideal position for a cardboard box design on the continuous cardboard and aligns the cutting pattern so that there is as little waste as possible.

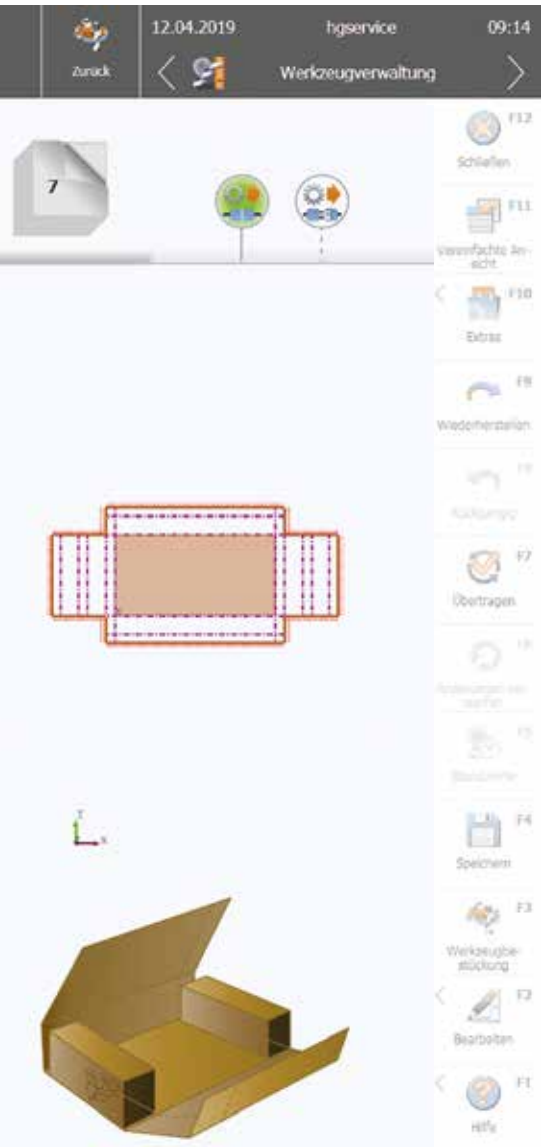

The next generation of powerTouch: **powerTouch2**

Faster, more comfortable, clearer: Enjoy the benefits of our further improved powerTouch user interface. We have optimized our standardized operating concept and further adapted it to our customers' requirements.

Controlling your HOMAG machines is now even faster and more intuitive. The new, modern design has a clear structure. The innovative touch operation allows you to achieve the desired result easily and comfortably.

With the new powerTouch generation, you can enter information at your machine even more quickly. Compared to the previous version, you can achieve a time saving of up to 30%. This is possible thanks to new features, such as automatic word completion, a pop-up keyboard that can be kept open and Windows-like functions, such as the selection of common actions directly via the start button.

THE HIGHLIGHTS AT A GLANCE:

- Direct and efficient operation, up to 30% faster
- Clearer and more informative thanks to additional information and live illustrations instead of program icons
- New applications for operating and controlling machines and systems (e.g. NCCenter in the PC87 control system on CNC machines or woodCommander 4 on throughfeed machines)
- Fresh, attractive design, based on the new HOMAG machine design



The **intelligent residual length management** reduces machine downtimes and simplifies stack changes.



When **production lists** are used, packaging production is automated. Interruptions with individual cuts are possible without the last settings being "forgotten".

HOMAG

 Settings
 Services
 Actions

 Back

- | | | | |
|---|---|---|---|
|  | ab 168,00 € *
MEHR INFO |  | ab 168,00 € *
MEHR INFO |
|  | Zuschnitt FEFCO 0422
VARIANTE
Variante wählen
ab 168,00 € *
MEHR INFO |  | Zuschnitt FEFCO 0425
VARIANTE
Variante wählen
ab 168,00 € *
MEHR INFO |
|  | Zuschnitt FEFCO 0426
VARIANTE
Variante wählen
ab 168,00 € *
MEHR INFO |  | Zuschnitt FEFCO 0428
VARIANTE
Variante wählen
ab 168,00 € *
MEHR INFO |
|  | Zuschnitt FEFCO 0429
VARIANTE
Variante wählen
ab 168,00 € *
MEHR INFO |  | Zuschnitt FEFCO 0452
VARIANTE
Variante wählen
ab 168,00 € *
MEHR INFO |
|  | Zuschnitt FEFCO 0453
VARIANTE
Variante wählen
ab 168,00 € *
MEHR INFO |  | Zuschnitt FEFCO 0454
VARIANTE
Variante wählen
ab 168,00 € *
MEHR INFO |
|  | Zuschnitt FEFCO 0456
VARIANTE
Variante wählen
ab 168,00 € *
MEHR INFO |  | Zuschnitt FEFCO 0478
VARIANTE
Variante wählen
ab 168,00 € *
MEHR INFO |

 Maschine bereit

 Daten

Zuschnitt X
Individualperfect.

PAQTEQ shop – Packaging design at the click of the mouse

In the PAQTEQ shop, packaging designs can be purchased directly from the machine and used immediately. The optimum packaging design is therefore always available on the PAQTEQ – quickly and without any complicated clarification processes.



In the **PAQTEQ shop** you can find a variety of cardboard box cuts, including many FEFCO standards for immediate use on the PAQTEQ C-250. Book our flat rate and have free access to all available cardboard box designs.



www.PAQTEQ-Shop.com



The right packaging design available immediately! – All cardboard box types have been tested!

- More than 230 types of cardboard box, with the number constantly increasing
- Reduced consulting time
- Detailed type and performance description based on a reference cardboard box
- All cardboard box types have been tested
- Available in less than 60 seconds
- Automatic update of existing cardboard boxes on download
- Flat-rate online shop

Modular expansion: Individual solutions from small to large

With HOMAG, you rely on flexible solutions. Regardless of whether series production or batch size 1, single sheet feed or continuous carton. Whether in stand-alone operation or integrated into a complex packaging line – the PAQTEQ C-250 carton cutting machine adapts flexibly to customer requirements and needs. It grows with its tasks. Depending on the requirements, it can be individually supplemented with a folding machine, automatic closing machine, robot insertion station or robot palletising to form a complete packaging line.

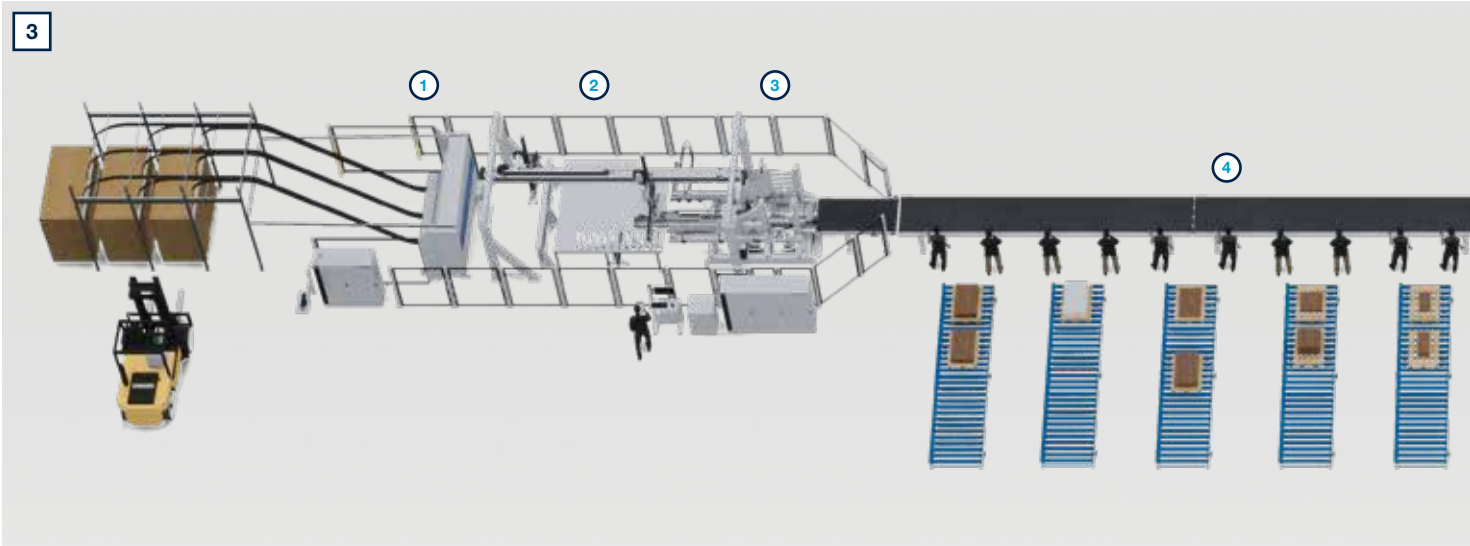
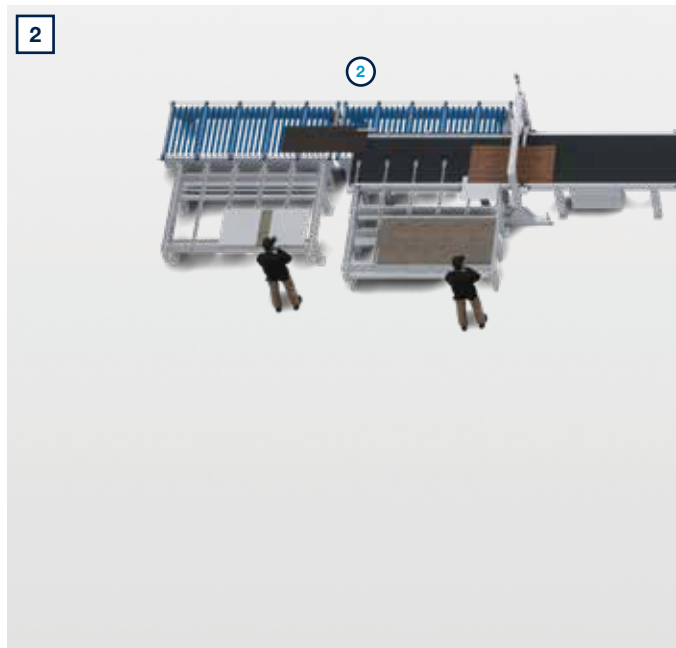
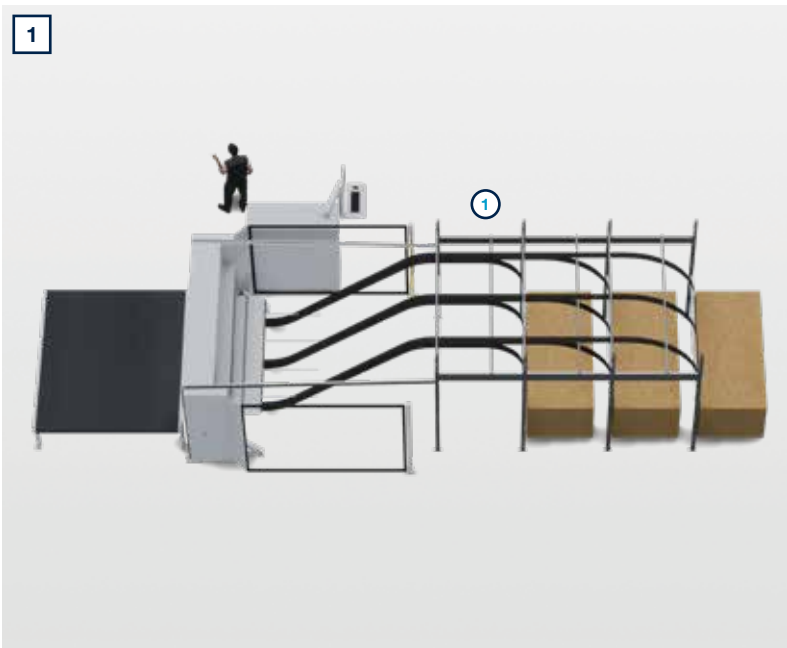

1 PAQTEQ in stand-alone operation

- ① Cardboard box cutting machine

2 PAQTEQ integration in a packaging line

- ① Cardboard box cutting machine
- ② Workpiece deposit station
- ③ Packaging conveyor
- ④ Cardboard box sealing machine
- ⑤ Manual stacking

Options that pay off:

- Connection to sorters
- Connection to assembly lines
- Line linking incl. waste disposal
- Pack AI / Software
- Volume scanner
- Folding table
- Carton labelling for internal logistics
- Connection of external label printers for shipping labels
- Consumables registration
- Waste optimisation 1 and 2
- Software options

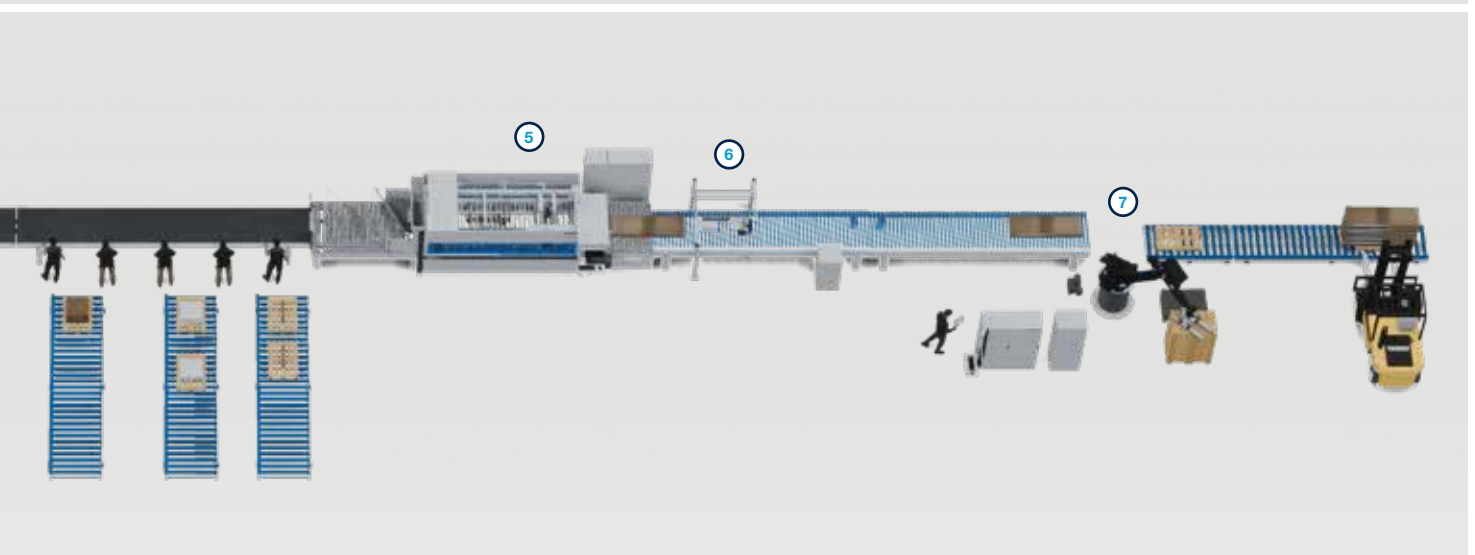
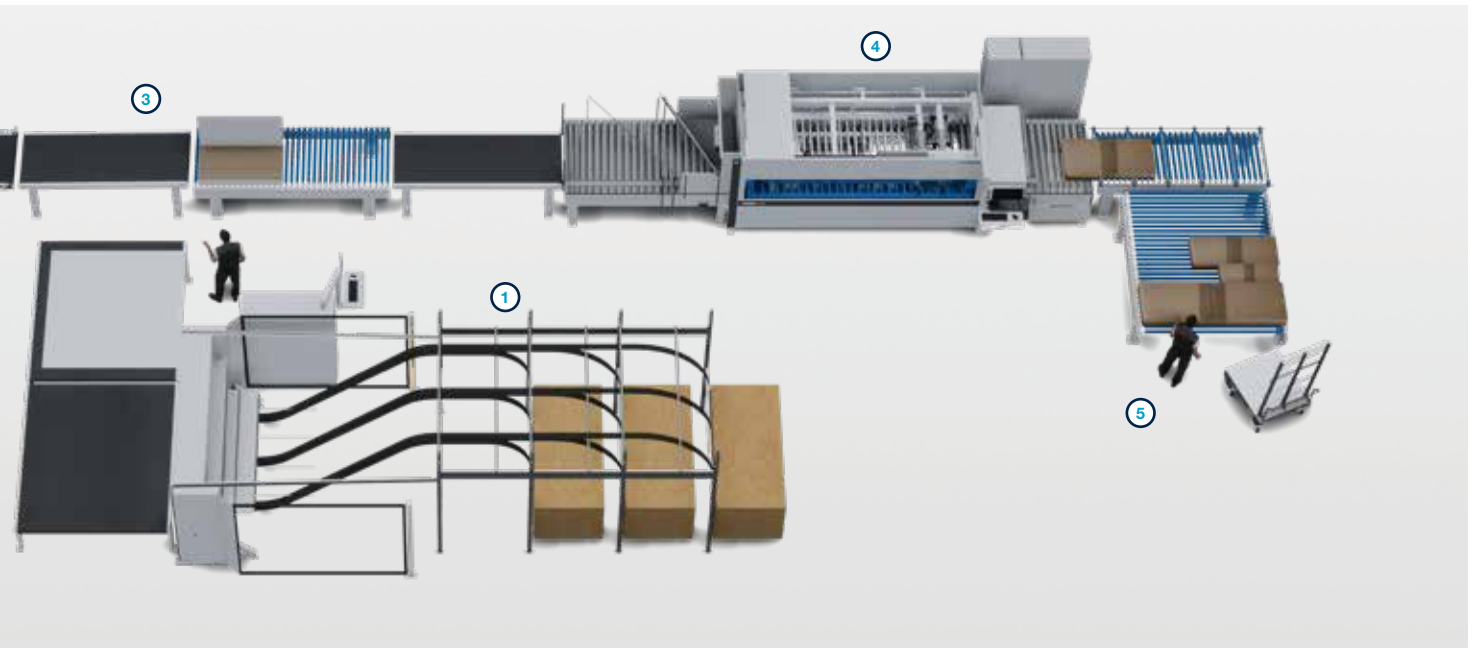

3 PAQTEQ integration in packaging line with robot destacking

- | | |
|---------------------------------|---------------------------------|
| ① Cardboard box cutting machine | ⑤ Cardboard box sealing machine |
| ② Alignment station | ⑥ Labeling station |
| ③ Cardboard box folding machine | ⑦ Robotic stacking |
| ④ Packaging conveyor | |

VALYOU

Our Mission, Your Performance.

LIFE CYCLE SERVICES

Improved performance, more efficient processes, faster help, assurance of availability and smarter working

TEAM & COVERAGE

Largest global service network in the industry with over 1,350 personnel.

INSTALLATION & COMMISSIONING

For a smooth start, we only let proven experts manage your setup.

OPERATION & CONTROL

After teaching your personnel the intuitive control system, our clever apps help to make the operator's life much easier.

MAINTENANCE & SERVICING

To keep things running, we're happy to take a preventative approach. You decide how often and how intensively you want the support to be. As we all know, prevention is better than the cure.

eSHOP & ONLINE ADVANTAGE

A few clicks and it's fixed. Receive exclusive advantages by ordering spare parts online, depending on market availability. shop.homag.com

HOTLINE & READINESS

When there's an emergency, we're here. Direct by phone, digitally via app or video, or with on-site support. We are close to you with over 90 regional service organizations worldwide. With more than 35,000 spare parts immediately available, we can deliver 85% of your orders fast.

TRAINING & EDUCATION

With classroom, live online or eLearning training, we offer flexible options to help you get knowledge. We conduct over 4,000 customer training courses every year, and we even have our own training centers in 19 countries

MODERNIZATION & IMPROVEMENT

Our modernization program is tailored to your machines and processes. We can evaluate your data and situation and advise you on the next step.

ANALYSIS & SUSTAINABILITY

On request, we analyze all your processes with proven tools and procedures (LeanSixSigma). We have a large, certified team of experts for this purpose.

FINANCING & CONSULTING

We offer you tailor-made financing concepts worldwide. With more than 60 years of experience and a close partner network of prominent banks and insurance companies to help us to find the right solution for you, we're always transparent and reliable in processing.

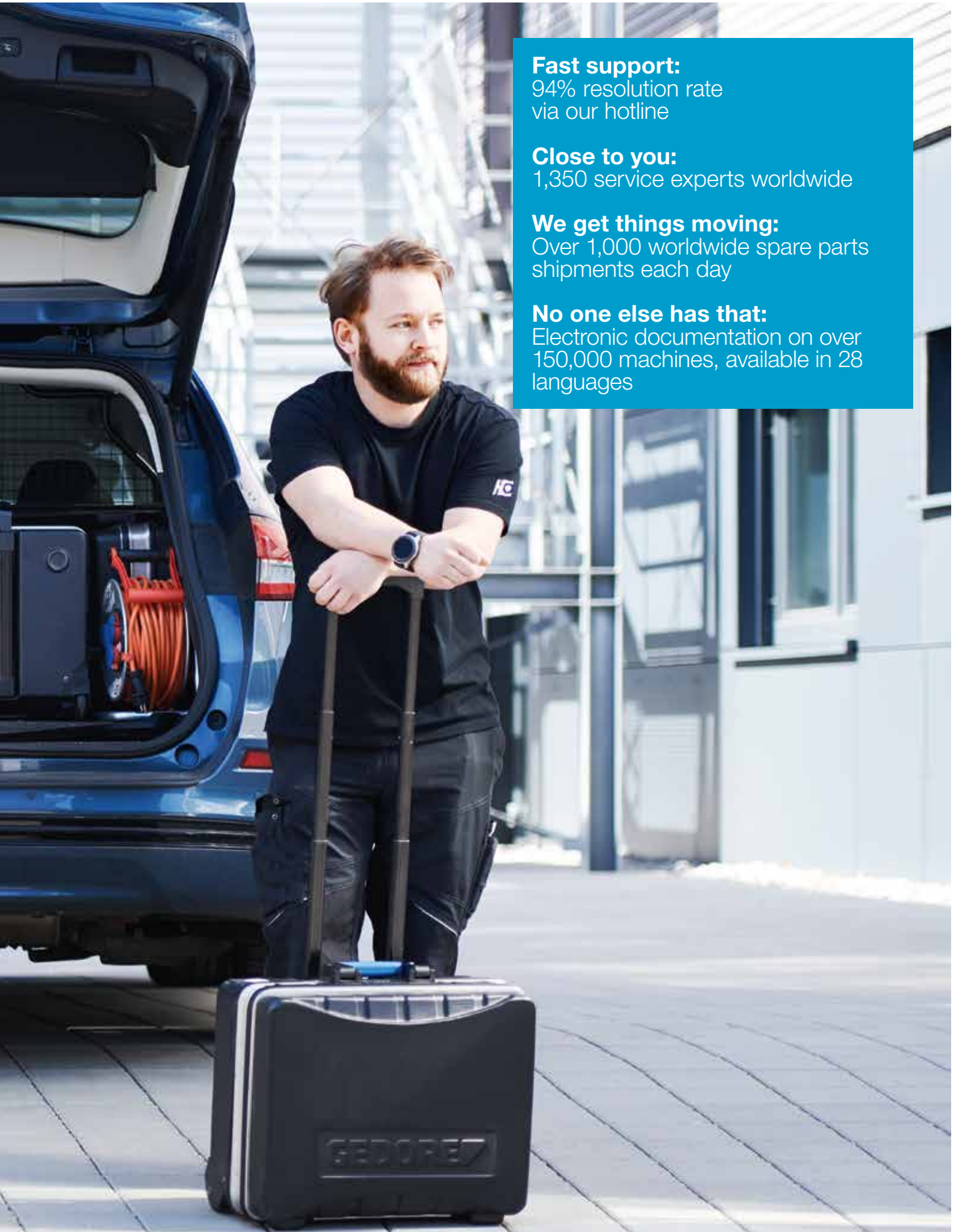

Fast support:
94% resolution rate
via our hotline

Close to you:
1,350 service experts worldwide

We get things moving:
Over 1,000 worldwide spare parts
shipments each day

No one else has that:
Electronic documentation on over
150,000 machines, available in 28
languages

Technical data

PAQTEQ C-250





TECHNICAL DATA	PAQTEQ C-250 (1,500 WIDTH)	PAQTEQ C-250 (2,500 WIDTH)
Length of cardboard box (outfeed)	min. 300 mm	min. 300 mm
Width of cardboard box (infeed)		
Single sheet	350 – 1.500 mm	350 – 2.500 mm
Continuous cardboard, single	350 – 1.500 mm	350 – 2.500 mm
Continuous cardboard, side-by-side	max. 1.350 mm	max. 2.350 mm
Stack height incl. 120 mm pallet	max. 2.150 mm	max. 2.150 mm
Stacking height with cardboard box changing system	1.300 mm	2.200 mm
Cutting tolerance		
Longitudinal direction	max. 0.15 %	max. 0.15 %
Transverse direction	max. +/- 2.0 mm	max. +/- 2.0 mm
Cardboard thickness	2.0 - 7.0 mm +/- 0.2 mm	2.0 - 7.0 mm +/- 0.2 mm
Cardboard box quality according to DIN 55468	1-wave, thickness up to approx. 4.0 mm (quality 1.10–1.40) 2-wave, thickness up to approx. 7.0 mm (quality 2.10–2.30)	1-wave, thickness up to approx. 4.0 mm (quality 1.10–1.40) 2-wave, thickness up to approx. 7.0 mm (quality 2.10–2.30)





6 questions – 6 answers: the quick PAQTEQ "needs checklist"...



Your packaging

Not made to measure	
	< 20%
	20–50%
	50%

Your packaging handling

Min. / Package	
	< 0,5 Min.
	> 0,5–2 Min.
	> 2 Min.

Your storage

Storage space	
	< 30m ²
	30–80m ²
	> 80m ²



Your shipping costs

Package/ truck filling level	
	> 90%
	90–70%
	< 70%

Your packaging variety

Number of articles	
	< 25
	25–40
	> 40

Your complaints

Complaint rate	
	< 1%
	1–5%
	> 5%

If something in this check is not in the "thumbs up" range, then you need to take action.

We would be happy to realise the savings potential with you. Feel free to contact us!



HOMAG Group AG

info@homag.com
www.homag.com

YOUR SOLUTION